



Product Description

The MS12 Return Loss Meter is the most widely deployed insertion loss and mandrel-free return loss measurement solution in the industry. The MS12 delivers accurate, reliable, and traceable results for optical cable assemblies and optical components.

Working closely with fiber optic market leaders, the MS12 platform has been tailored to accommodate critical fiber-optic testing needs. An internal monitoring feature maintains laser stability for reliable insertion loss testing. The internal return loss reference provides additional reliability and accuracy to return loss measurements. The multimode MS12 meets the IEC 61280-4-1 Encircled Flux standard.

KEY FEATURES

- SM 1310, 1490, 1550 and 1625 nm
- MM 850, 1300 nm
- RL: SM 80 dB
- RL: MM 50 dB
- Wide area integrating cavity detector

APPLICATIONS

- Cable assembly testing
- Ribbon fiber testing
- Simultaneous testing with multiple connector types
- Single and multifiber testing

COMPLIANCE

- Multimode meets IEC 61280-4-1 Encircled Flux standard

IN THE BOX

- MS05B/MS08B/MS10R
 - Power cord
 - PCI card
- MS12
 - Calibration certificate
 - Detector cap
 - FC detector adapter
 - Hybrid test jumper
 - SM: Power Level Adjustment jumper
- MS7
 - Test report
- MS4
 - USB cable

Cross Compatibility

EXFO's IQS-3250 IL/RL meters can be used with new JGR MS Mainframes. This allows users to seamlessly expand and grow their production floors at a reduced cost.

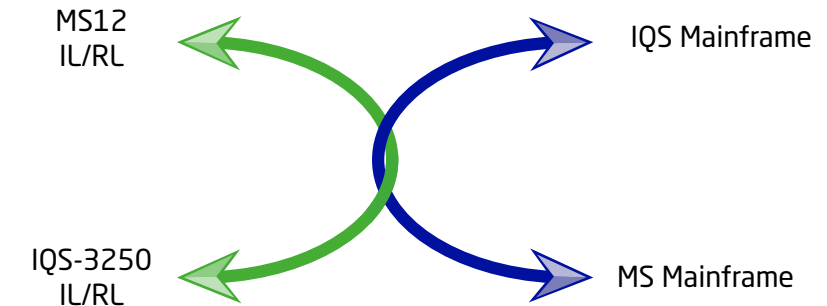

Production Friendly Software

Closely listening to customers throughout the years, JGR's MS12 Software has been developed with production in mind. It is very easy to navigate allowing for new test configurations to be setup in seconds and saved for future use.

The software takes care of managing all test sequences, databases and results to maximize efficiency in production while keeping its operation simple. The software always comes at no charge with the MS12001 platform.

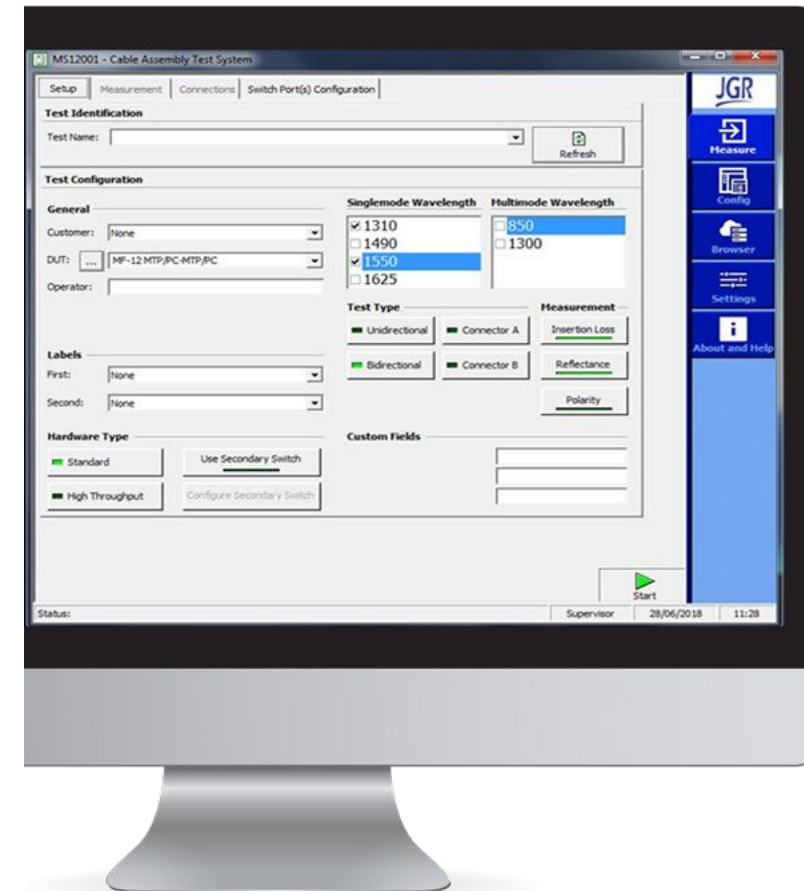

Modularity

Modular by design, the MS Mainframes allow both single-mode and multimode insertion loss and return loss testing within a single MS Mainframe station.



The modularity also allows for easy future expansion into multi-fiber testing with the addition of an MS7 switch module.

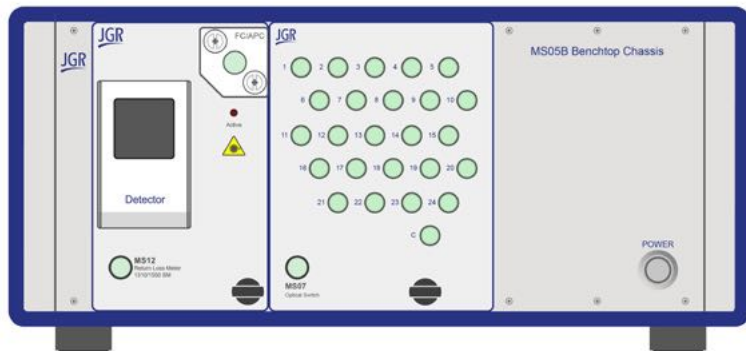

With the use of JGR's 10-slot MS10R mainframe, it is possible to have a single station for multichannel IL/RL testing of both SM and MM. An MS4 Polarity Test Module can be added for further functionality and station optimization.

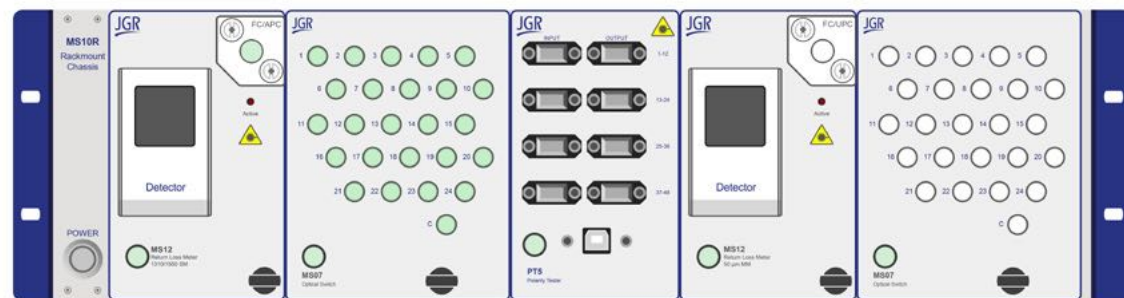

Accurate, Repeatable, and Reliable

The integrating cavity detector is a standard feature of the MS12 Return Loss Module. The latest design of the integrating cavity boasts a wider aperture allowing for testing of simplex, duplex, and multifiber assemblies without the need to disconnect. The integrating cavity used has negligible polarization dependence, therefore, accuracy and repeatability of the measurements are increased. Remote-head cavity detector option available for additional test station flexibility.

The insertion loss measurement has been developed in accordance with the TIA/EIA-455-34A Standard FOTP-34A, "Interconnection Device Insertion Loss Test" and IEC61300-3-4, "Basic Test and Measurement Attenuation"

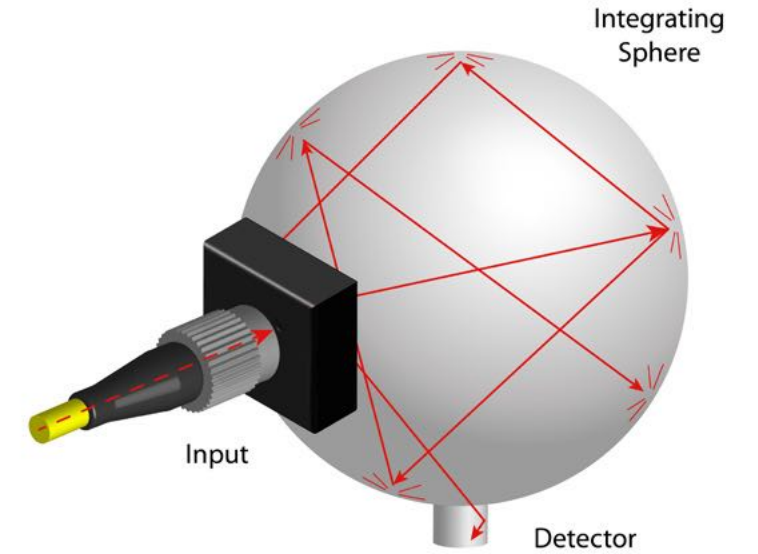

Flexible

Based on advanced time domain technology and the wide aperture integrating cavity detector, the MS12 Return Loss Meter meter will deliver accurate and repeatable insertion loss and return loss measurements for your fiber optic cable assemblies. The continuous internal monitoring ensures accurate insertion loss measurements by compensating for any source power variations during production hours.

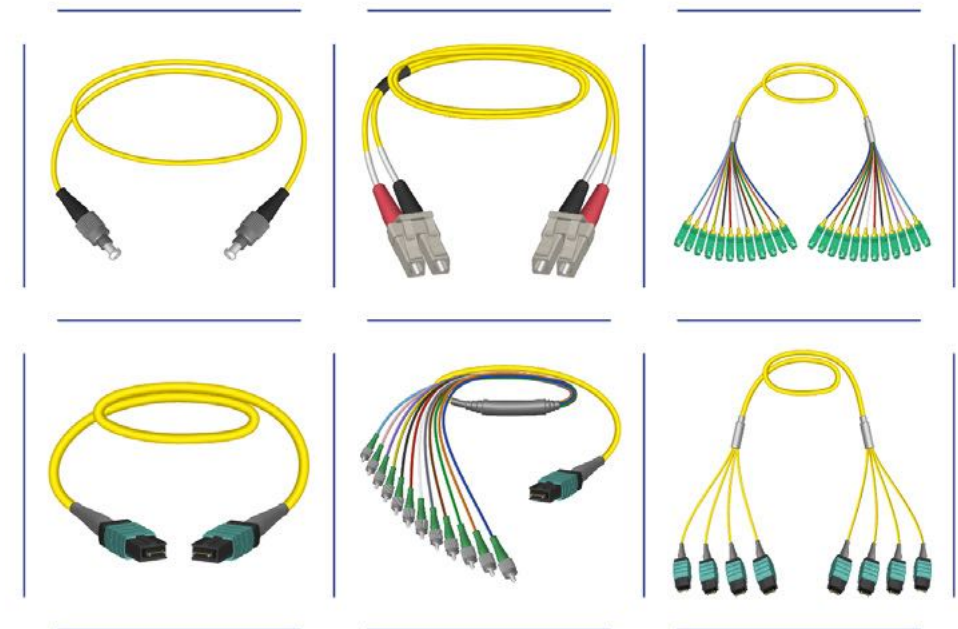

Ordering Scheme & Instructions

1 - Configure MS12 Return Loss Meter

Single-mode Return Loss Module (2 slots)

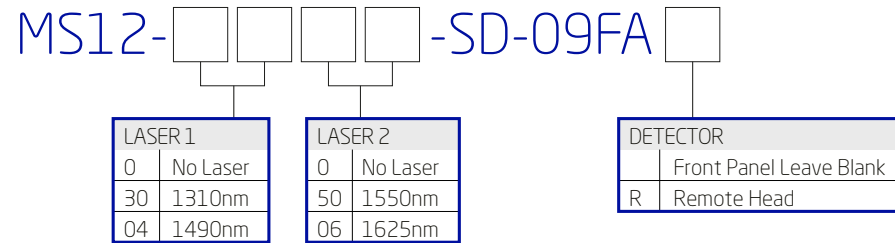

- Single-mode version comes with FC/APC output connector

Multimode Return Loss Module (2 slots)

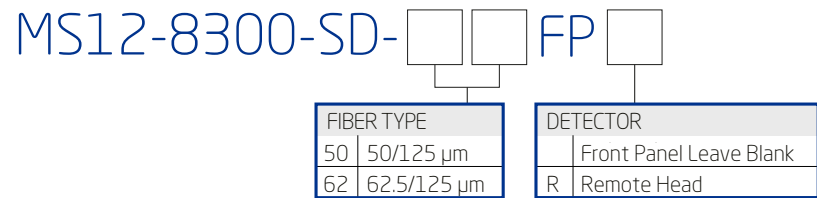

- The standard multimode versions contain two lasers at 850 and 1300 nm and comes with an FC/UPC output connector

2 - Configure MS7 Optical Switch **if no switch needed, skip ahead*

Switch Module (1-5 slots)

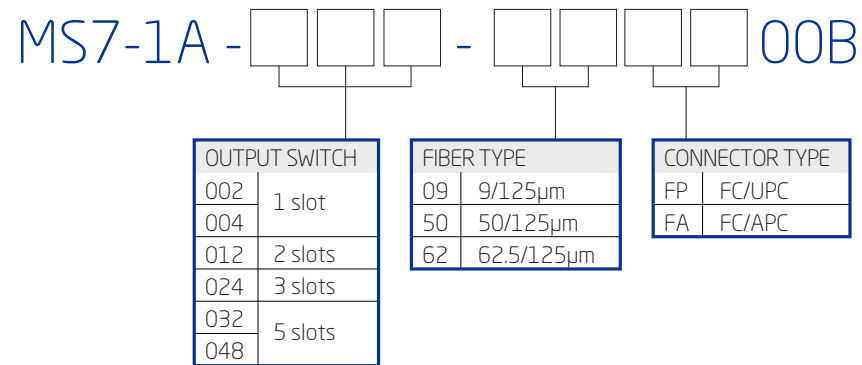

3 - Configure MS4 Polarity Test Module **if no polarity needed, skip ahead*

Polarity Test Module (2 slots)

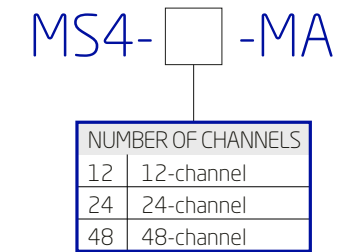

4 - Add up all module sizes to determine MS Mainframe size

MS Mainframes

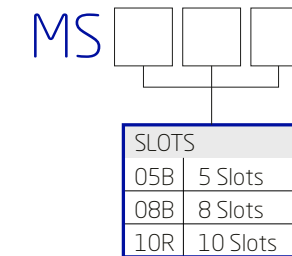

5 - Select Required Detector Adapters

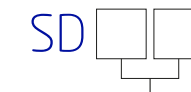

TYPE							
00	Cap	14	MU	20	DA113 Barrel	38	MTP0/MPO-16
01	FC	15	E2000	21	BFA3000 Barrel	64	CS
02	ST	16	Universal 2.5.	26	Universal 1.6	67	SN
03	SC	17	MTP/MPO	34	LC Duplex	68	MDC
04	Universal 1.25.	18	LC	35	Optitap		
12	MT	19	MT-RJ	37	MXC		

More detectors available upon request. See more details on pg 78.

Optical/Electrical Specifications

Parameter	Specification	
	Single-mode	Multimode
Fiber Type (μm)	9/125	50/125 62.5/125
Encircled Flux Standard	N/A	IEC 61280-4-1
Operating Wavelengths (nm)	1310 / 1550 or 1490 / 1625	850/1300
Insertion Loss Uncertainty (dB)	± 0.03	+/- 0.05
Insertion Loss Stability (dB) ¹	± 0.004	± 0.01
Return Loss (dB)	30 to 80	10 to 50
Return Loss Accuracy (dB)	± 1.0 (30 to 70)	± 1.2 (10 to 30)
	± 1.7 (70 to 75)	± 1.5 (30 to 40)
	± 2.2 (75 to 80)	± 1.6 (40 to 43)
		± 2.9 (43 to 50)
Return Loss Repeatability (dB) ²	± 0.1 (30 to 65)	± 0.2 (10 to 30)
	± 0.2 (65 to 70)	± 0.4 (30 to 40)
	± 0.4 (70 to 75)	± 0.6 (40 to 43)
	± 1.5 (75 to 80)	± 1.8 (43 to 50)
Testing Time (s)	< 3 per wavelength	
Cable Assembly Length (m)	1.7 to 1500	1.7 to 500
Detector Type	Integrating cavity	
Test Method	End to end / bidirectional	

Notes:

¹ For a stable connection over a period of 15 minutes.² For a stable connection over 10 measurements.

Mechanical/Environmental Specifications

Parameter	Specification
Number of slots	2
Unit Dimensions W x H x D (cm)	7.4 x 12.5 x 28.2
Shipping Box Dimensions W x H x D (cm)	43 x 27 x 47
Unit Weight (kg)	0.9
Total Shipment Weight (kg)	< 5 (depends on the number of modules)
Operating Temperature (°C)	0 to 40
Storage Temperature (°C)	-40 to 60
Humidity (Non-condensing)	Maximum 80%, no condensing at 40°C

Optical/Electrical Specifications

Parameter	Specification			
	1x2, 2x2		1x4, 1x12, 1x24, 1x32, 1x48, 1x72	
	Single-mode	Multimode	Single-mode	Multimode
Wavelength Range (nm)	1250 - 1660	840 - 1310	1250 - 1670	840 - 1350
Insertion Loss (dB) ¹	0.7			
Backreflection (dB) ¹	≤ -50	≤ -35	≤ -60	≤ -40
PDL (dB)	< 0.05	N/A	< 0.05	N/A
Repeatability (random switching) (dB)	N/A		+/- 0.025	
Repeatability (sequential) (dB)	± 0.01		± 0.005	
Crosstalk (maximum) (dB)	-80			
Maximum Input Power (mW)	300			
Switching Time (ms)	10		300	
Switch Life	10 ⁸ cycles			

Notes:

¹ Excluding connectors.

Mechanical/Environmental Specifications

Parameter	Specification				
	1x2, 2x2	1x4, 1x12	1x24	1x32, 1x48	1x72
Number of slots	1	2	3	5	7
Unit Dimensions W x H x D (cm)	3.6 x 12.5 x 28.2	7.4 x 12.5 x 28.2	11.2 x 12.5 x 28.2	18.8 x 12.5 x 28.2	26.8 x 12.5 x 28.2
Shipping Box Dimensions W x H x D (cm)	43 x 27 x 47				
Unit Weight (kg)	0.5	0.7	0.9	1.4	2
Total Shipment Weight (kg)	< 5 (depends on the number of modules)				
Operating Temperature (°C)	0 to 40				
Storage Temperature (°C)	-40 to 60				
Humidity (Non-condensing)	Maximum 80% RH at 40°C				

Optical/Electrical Specifications

Parameter	Specification	
Operating Wavelengths (nm)	650	
Laser Class	2	
Optics Interface	Output	MTP/MPO APC Male (SM)
	Input	MTP/MPO UPC Male (MM)
Detected Polarities	A, B, C and unlimited custom mappings	
Test Time (12ch)	<2s	
IL Tolerance	<6dB	

Mechanical/Environmental Specifications

Parameter	Specification
Number of slots	2
Unit Dimensions W x H x D (cm)	11.2 x 12.5 x 28.2
Shipping Box Dimensions W x H x D (cm)	43 x 27 x 47
Unit Weight (kg)	0.9
Total Shipment Weight (kg)	<5 (depends on the number of modules)
Operating Temperature (°C)	0 to 40
Storage Temperature (°C)	-40 to 60
Humidity (Non-condensing)	Maximum 80% RH at 40°C

Mechanical/Environmental Specifications

Parameter	Specification		
	MS05B	MS08B	MS10R
Form factor	Benchtop		Rackmount
Number of slots	5	8	10
Unit Dimension W x H x D (cm)	36 x 15 x 34	47 x 15 x 34	48.5 x 44.5 x 13
Shipping Box Dimensions W x H x D (cm)	42 x 27 x 48	53 x 32 x 57	65 x 58 x 33
Unit Weight (kg)	7	7	7
Total Shipment Weight (kg)	8	8	8
Operating Temperature (°C)	0 to 40	0 to 40	0 to 40
Storage Temperature (°C)	-40 to 70	-40 to 70	-40 to 70
Humidity (Non-condensing)	Maximum 95% RH from 0 to 40°C	Maximum 95% RH from 0 to 40°C	Maximum 95% RH from 0 to 40°C
Input Voltage	100 - 240 V AC, 50 - 60 Hz		
Power Consumption (VA)	80 Maximum		

